

DEOMATIC

Pièces détachées adaptables pour:
ZANUSSI

DeoMatic Horeca-Industrie s.p.r.l.
Pièces détachées pour Cuisines Industrielles
34 rue des alliés Bongenotenstraat 34
1190 Bruxelles 1190 Brussel

Tel. : 02 343 97 64
Fax : 02 343 90 31
deomatic@skynet.be
www.deomatic.be

Partner of  **GEV GROUP**

DEONMATIC



Systèmes de lavage et de rinçage

Page 4



Divers et réservoirs d'air

Page 6



Systèmes de vidange et de filtre

Page 8



Mécanique de porte et de capot

Page 11



Composants électriques

Page 13

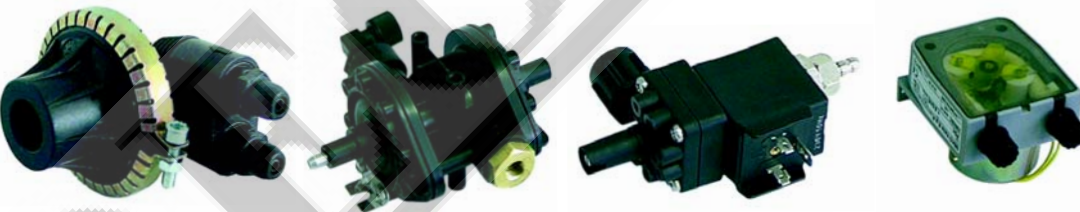

Technique de dosage

Page 19



Résistances et surchauffeurs

Page 19



Pompes et pièces de rechange

Page 21

Systèmes de lavage et de rinçage

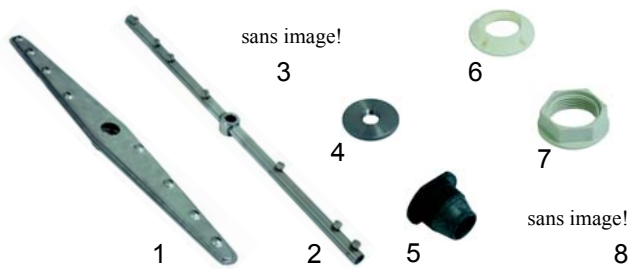

| Fig. | Réf. | Description | Modèle | Réf. C. |
|------|--------|---------------------------|--------------|---------|
| 1 | 504500 | bras de lavage | | 049044 |
| 2 | 504501 | bras de rinçage | | 049049 |
| 3 | 504502 | axe de bras de rinçage | LB1 | 049046 |
| 4 | 504503 | écrou plat | LB2, Z1, Z2, | 049047 |
| 5 | 504504 | douille de bras de lavage | GW1, GW2 | 049042 |
| 6 | 504505 | écrou bras lavage | W51, W52 | 049043 |
| 7 | 504506 | écrou/ collecteur | | 049039 |
| 8 | 504507 | joint | | 049038 |



| Fig. | Réf. | Description | Modèle | Réf. C. |
|------|--------|-------------------------------|---------------|---------|
| 1 | 510119 | bras de lavage, complet | | 069576 |
| 2 | 510108 | axe de bras de rinçage | LTB11, LTB12, | 069445 |
| 3 | 510031 | collecteur | LTB22 | 069443 |
| 4 | 518036 | joint (durite de refoulement) | | 046878 |

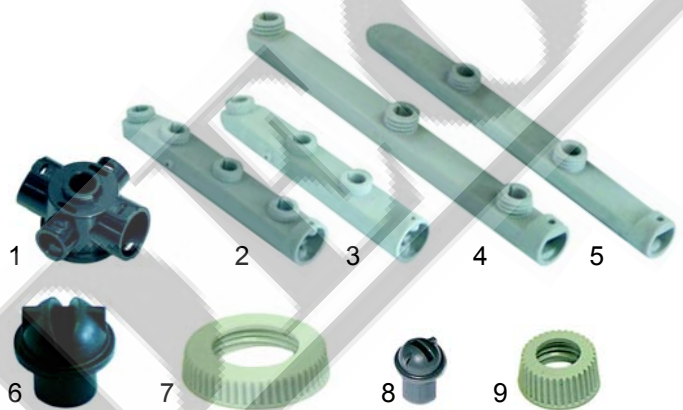

| Fig. | Réf. | Description | Modèle | Réf. C. |
|------|--------|---------------------------------------|--------|---------|
| 1 | 510010 | partie centrale tourniquet lavage | | 69452 |
| 2 | 518382 | bras de lavage/ droit | | |
| 3 | 518385 | bras de lavage/ gauche | | |
| 4 | 518384 | bras de rinçage/ droit | LTB11, | |
| 5 | 518383 | bras de rinçage/ gauche | LTB12, | |
| 6 | 518004 | gicleur lavage complet | LTB22 | 069449 |
| 7 | 510131 | raccord olive/ gicleur lavage complet | | 069448 |
| 8 | 510139 | gicleur rinçage | | 069451 |
| 9 | 510130 | raccord olive/ gicleur rinçage | | 069450 |

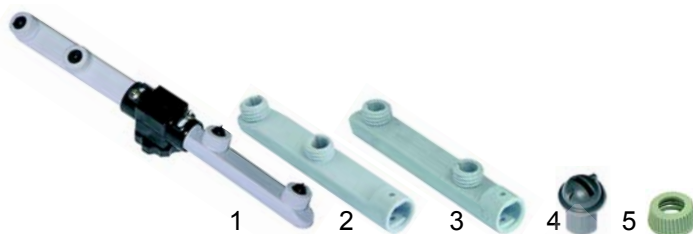

| Fig. | Réf. | Description | Modèle | Réf. C. |
|------|--------|---------------------------------|--------|---------|
| 1 | 510118 | bras de rinçage, complet | | 069577 |
| 2 | 518328 | bras de rinçage/ droit | LTB11, | |
| 3 | 518329 | bras de rinçage/ gauche | LTB12, | |
| 4 | 510139 | gicleur rinçage | LTB22 | 069451 |
| 5 | 510130 | raccord olive (bras de rinçage) | | 069450 |



| Fig. | Réf. | Description | Modèle | Réf. C. |
|------|--------|---------------------------------------|--------|---------|
| 1 | 510135 | bras gicleur de lavage/ bras fixe | | 069640 |
| 2 | 510147 | gicleur lavage complet | LTB11, | 069641 |
| 3 | 518482 | raccord olive, gicleur lavage complet | LTB12, | 069642 |
| 4 | 510112 | vis fixation bras | LTB22 | 069440 |
| 5 | 518279 | capot | | 069444 |

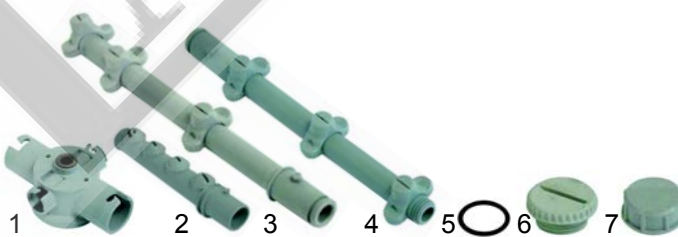

| Fig. | Réf. | Description | Modèle | Réf. C. |
|------|--------|-----------------------------------|------------|---------|
| 1 | 504508 | partie centrale tourniquet lavage | | 049293 |
| 2 | 504509 | bras de lavage | | 049295 |
| 3 | 504510 | bras de rinçage | | 049297 |
| 4 | 504511 | bras de rinçage | LS5, LS32, | 049298 |
| 5 | 504512 | joint torique (bras de rinçage) | LS33 | 047473 |
| 6 | 504513 | capuchon (bras de lavage) | | 049296 |
| 7 | 504514 | capuchon (bras de rinçage) | | 049299 |



| Fig. | Réf. | Description | Modèle | Réf. C. |
|------|--------|-------------------------|------------|---------|
| 1 | 504515 | protection (écrou plat) | | 049294 |
| 2 | 504516 | écrou plat | | 047282 |
| 3 | 504517 | écrou (collecteur) | | 048330 |
| 4 | 504537 | joint | LS5, LS32, | 048236 |
| 5 | 504519 | clips | LS33 | 048979 |
| 6 | 504520 | diaphragme | | 048820 |
| 7 | 504521 | collecteur/ en bas | | 049290 |



| Fig. | Réf. | Description | Modèle | Réf. C. |
|------|--------|-------------------------|------------|---------|
| 1 | 504515 | protection (écrou plat) | | 049294 |
| 2 | 504516 | écrou plat | | 047282 |
| 3 | 504522 | axe de bras de rinçage | LS5, LS32, | 049292 |
| 4 | 504512 | joint torique | LS33 | 047473 |
| 5 | 504523 | écrou (collecteur) | | 048824 |
| 6 | 504524 | joint | | 048823 |



| Fig. | Réf. | Description | Modèle | Réf. C. |
|------|--------|------------------------|---------------------|---------|
| 1 | 504535 | bras de lavage | | 048247 |
| 2 | 504526 | bras de rinçage | | 048716 |
| 3 | 504527 | axe de bras de rinçage | LS10, LS12, LS14 | 048290 |
| 4 | 504528 | écrou plat | | 048632 |
| 5 | 504529 | distributeur eau | | 048401 |



| Fig. | Réf. | Description | Modèle | Réf. C. |
|------|--------|------------------------|--------------------------|----------------|
| 1 | 504525 | bras de lavage | | 048821, 048336 |
| 2 | 504526 | bras de rinçage | LS6, LS7D, LS7, LS8D, | 048716, 048542 |
| 3 | 504527 | axe de bras de rinçage | LS8, LS62, | 048290 |
| 4 | 504528 | écrou plat | LS63 | 048632 |
| 5 | 504529 | distributeur eau | | 048401 |

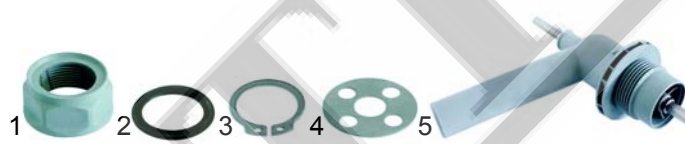

| Fig. | Réf. | Description | Modèle | Réf. C. |
|------|--------|--------------------|---------------------|---------|
| 1 | 504536 | écrou (collecteur) | | 048237 |
| 2 | 504537 | joint | | 048236 |
| 3 | 504519 | clips | LS10, LS12, LS14 | 048979 |
| 4 | 504530 | diaphragme | | 048931 |
| 5 | 504539 | collecteur/en bas | | 048235 |

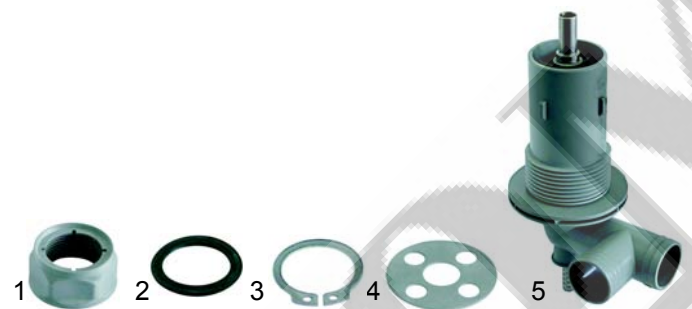

| Fig. | Réf. | Description | Modèle | Réf. C. |
|------|--------|--------------------------|--------------------------|----------------|
| 1 | 504517 | écrou (collecteur) | | 048330 |
| 2 | 504537 | joint | | 048236 |
| 3 | 504519 | clips | LS6, LS7D, LS7, LS8D, | 048979 |
| 4 | 504520 | diaphragme | LS8, LS62, | 048820 |
| 4 | 504530 | diaphragme (L58/ ancien) | LS63 | 048645, 048931 |
| 5 | 504531 | collecteur/en bas | | 048819, 048329 |



| Fig. | Réf. | Description | Modèle | Réf. C. |
|------|--------|-----------------------------|------------------|---------|
| 1 | 504540 | bras de lavage | LS360, LS365 | 068660 |
| 2 | 504541 | bras de rinçage | | 046371 |
| 3 | 504516 | écrou plat | LS360, LS365, | 047282 |
| 4 | 504543 | gicleur rinçage | LS540, | 046272 |
| 5 | 504544 | joint torique | LS720, | 067898 |
| 6 | 504545 | étrier pour buse de rinçage | LS860 | 046273 |
| 7 | 504546 | capuchon | | 046266 |



| Fig. | Réf. | Description | Modèle | Réf. C. |
|------|--------|--------------------|-------------------------|---------|
| 1 | 504523 | écrou (collecteur) | LS6 | 048824 |
| 2 | 504524 | joint | | 048823 |
| 3 | 504532 | bras rinçage inox | LS7D, LS7, LS8D, LS8 | 048333 |
| 4 | 504533 | joint | | 046366 |
| 5 | 504534 | collecteur/en haut | | 046368 |



| Fig. | Réf. | Description | Modèle | Réf. C. |
|------|--------|-----------------------------|--------------------------------|---------|
| 1 | 504547 | écrou plat (bras de lavage) | | 047283 |
| 2 | 504548 | douille (bras de lavage) | LS360, LS365, LS540, LS720, | 045771 |
| 3 | 504549 | axe de bras de rinçage | LS860 | 046363 |
| 4 | 504550 | distributeur eau | | 046362 |



| Fig. | Réf. | Description | Modèle | Réf. C. |
|------|--------|---------------------|----------------------|---------|
| 1 | 504551 | collecteur/ en bas | LS360, LS365, LS540, | 046373 |
| 2 | 504552 | joint torique | LS720, LS860 | 027301 |
| 3 | 504534 | collecteur/ en haut | LS360, LS365, LS540, | 046368 |
| 4 | 504554 | collecteur/ en haut | LS860 | 046547 |



| Fig. | Réf. | Description | Modèle | Réf. C. |
|------|--------|---------------|-----------------------------|---------|
| 1 | 504555 | écrou | LS540, LS720, LS860, LS1086 | 047891 |
| 2 | 504556 | joint torique | | 047929 |
| 3 | 504557 | ped | LS540 | 047893 |
| 4 | 504558 | ped | LS720, LS860, LS1080 | 047907 |
| 5 | 504559 | joint | | 047928 |



| Fig. | Réf. | Description | Modèle | Réf. C. |
|------|--------|-----------------|----------------------|---------|
| 1 | 504560 | tube évacuation | LS360, LS365 | 046400 |
| 2 | 504561 | joint | | 067768 |
| 3 | fini | tube évacuation | LS540 | 046374 |
| 3 | 504563 | tube évacuation | LS720, LS860, LS1080 | 046544 |
| 4 | 504564 | joint torique | | 065506 |

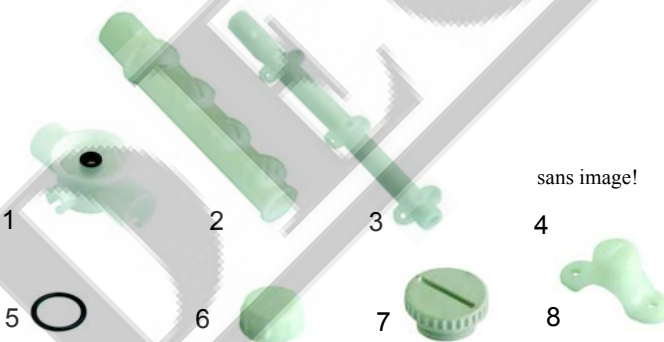

| Fig. | Réf. | Description | Modèle | Réf. C. |
|------|--------|-----------------------------------|--------|---------|
| 1 | 504565 | partie centrale tourniquet lavage | | 047990 |
| 2 | 504566 | bras de lavage | | 047470 |
| 3 | 504567 | bras de rinçage/ court | | 048142 |
| 4 | fini | bras de rinçage/ longue | LS510, | 047889 |
| 5 | 504512 | joint torique (bras de rinçage) | LS520, | 047473 |
| 6 | 504570 | capuchon (bras de rinçage) | LS521 | 047475 |
| 7 | 504571 | capuchon (bras de lavage) | | 047471 |
| 8 | 504572 | gicleur rinçage | | 047927 |



| Fig. | Réf. | Description | Modèle | Réf. C. |
|------|--------|-------------------------|--------|---------|
| 1 | 504542 | protection (écrou plat) | | 047991 |
| 2 | 504516 | écrou plat | LS510, | 047282 |
| 3 | 504573 | axe de bras de rinçage | LS520, | 047464 |
| 4 | 504574 | joint torique | LS521 | 046376 |
| 5 | 504575 | diaphragme | | 046361 |

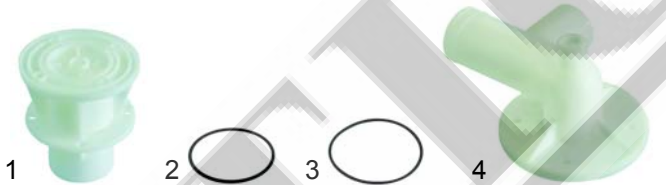

| Fig. | Réf. | Description | Modèle | Réf. C. |
|------|--------|--------------------------|--------|---------|
| 1 | 504576 | capot | | 048145 |
| 2 | 504577 | joint torique/ intérieur | LS510, | 047462 |
| 3 | 504578 | joint torique/ extérieur | LS520, | 045462 |
| 4 | 504579 | collecteur | LS521 | 047461 |

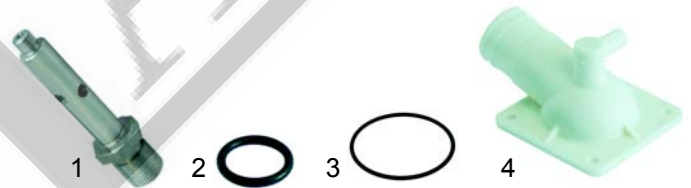

| Fig. | Réf. | Description | Modèle | Réf. C. |
|------|--------|------------------------|--------|---------|
| 1 | 504573 | axe de bras de rinçage | | 047464 |
| 2 | 504574 | joint torique | LS510, | 046376 |
| 3 | 504580 | joint | LS520, | 046366 |
| 4 | 504534 | collecteur/ en haut | LS521 | 046368 |

Divers



| Fig. | Réf. | Description | Modèle | Réf. C. |
|------|--------|-------------|--------|---------|
| 1 | 504582 | pièces X | | 049073 |
| 2 | 504583 | raccord Y | | 048195 |
| 3 | 504584 | raccord Y | | 049289 |



| Fig. | Réf. | Description | Modèle | Réf. C. |
|------|--------|--------------------|--------|---------|
| 1 | 504585 | filtre protecteur | | 048746 |
| 2 | 504586 | filtre protecteur | | 048834 |
| 3 | 504587 | clapet anti-retour | | 048414 |

Mécanique de produit de rinçage



| Fig. | Réf. | Description | Modèle | Réf. C. |
|------|--------|--------------------|--------|---------|
| 1 | 516101 | valve d'aspiration | | 049332 |
| 2 | 510789 | valve d'aspiration | | 048191 |

Adoucisseur

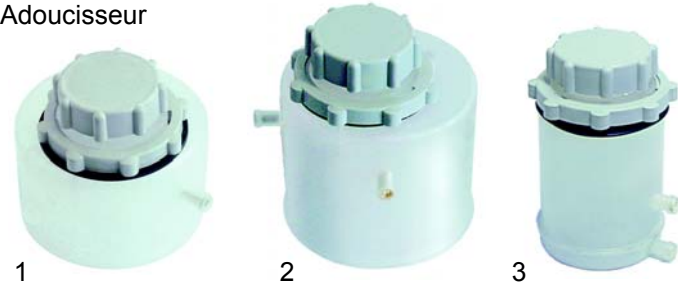

| Fig. | Réf. | Description | Modèle | Réf. C. |
|------|--------|--------------------|--------------|----------------|
| 1 | 504045 | bac a sel, complet | LB1, LB2 | 049075 |
| 2 | 510929 | bac a sel, complet | LTB12, LTB22 | 069575, 069471 |
| 3 | 510032 | bac a sel, complet | | 069680 |



| Fig. | Réf. | Description | Modèle | Réf. C. |
|------|--------|-------------|--------------|----------------|
| 1 | 510015 | couvrele | | 069467 |
| 2 | 510072 | joint | LTB12, LTB22 | 049245, 069468 |
| 3 | 510018 | écrou | | 069469 |
| 4 | 510071 | joint | | 049244, 069470 |



| Fig. | Réf. | Description | Modèle | Réf. C. |
|------|--------|-------------|--------|---------|
| 1 | 510109 | couvrele | | 069472 |
| 2 | 510071 | joint | LTB11 | 069470 |
| 3 | 510110 | écrou | | 069552 |



| Fig. | Réf. | Description | Modèle | Réf. C. |
|------|--------|-------------|--------------|---------|
| 1 | 505102 | adoucisseur | LB1, LB2 | 049074 |
| 2 | 530000 | adoucisseur | LTB11, LTB12 | 069476 |



| Fig. | Réf. | Description | Modèle | Réf. C. |
|------|--------|--------------------------|----------|----------------|
| 1 | 504690 | récepteur produit lavage | | 049024 |
| 2 | 504691 | raccord tuyau | | 049026 |
| 3 | 504692 | joint | LB1, LB2 | 049201, 067292 |
| 4 | 504693 | filtre | | 049022 |
| 5 | 504694 | ressort | | 049023 |
| 6 | 504695 | clapet | | 049021 |



| Fig. | Réf. | Description | Modèle | Réf. C. |
|------|--------|---------------------------------------|---------------------|---------|
| 1 | 510100 | réservoir, complet/ connexion latéral | | 069521 |
| 2 | 510099 | réservoir, complet/ connexion devant | LTB11, LTB12, LTB22 | 069547 |



| Fig. | Réf. | Description | Modèle | Réf. C. |
|------|--------|-------------------------|---------------------|---------|
| 1 | 510077 | joint torique | | 069644 |
| 2 | 510105 | manchon de raccordement | | 069646 |
| 3 | 510016 | raccord chambre | LTB11, LTB12, LTB22 | 069645 |
| 4 | 510014 | joint | | 069525 |

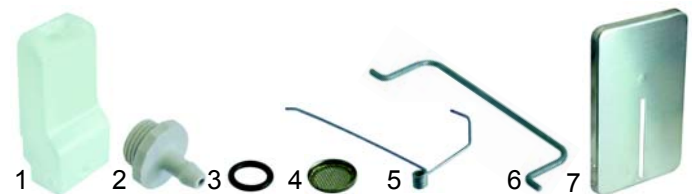

| Fig. | Réf. | Description | Modèle | Réf. C. |
|------|--------|---------------|-----------------|----------------|
| 1 | 504696 | réservoir | | 049975 |
| 2 | 504691 | raccord tuyau | | 049026 |
| 3 | 504692 | joint | LS5, LS32, LS33 | 049201, 067292 |
| 4 | 504693 | filtre | | 049022 |
| 5 | 504697 | ressort | | 048279 |
| 6 | 504694 | ressort | | 049023 |
| 7 | 504698 | clapet | | 048363 |

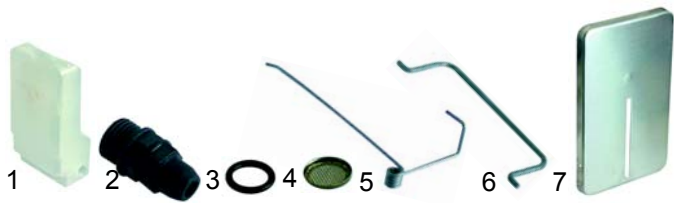

| Fig. | Réf. | Description | Modèle | Réf. C. |
|------|--------|---------------|--------|----------------|
| 1 | 504690 | réservoir | | 049024 |
| 2 | 504699 | raccord tuyau | | 049941 |
| 3 | 504692 | joint | LS6 | 067292, 049292 |
| 4 | 504693 | filtre | | 049022 |
| 5 | 504697 | ressort | | 048279 |
| 6 | 504694 | ressort | | 049023 |
| 7 | 504698 | clapet | | 048363 |



| Fig. | Réf. | Description | Modèle | Réf. C. |
|------|--------|-------------|--------|---------|
| 1 | 504700 | réservoir | | 068630 |
| 2 | 504701 | couvercle | | 068644 |
| 3 | 504702 | tube bac | LS7 | 068650 |
| 4 | 504703 | joint | | 048434 |
| 5 | 504704 | goupille | | 068627 |
| 6 | 504705 | ressort | | 068645 |
| 7 | 504706 | clapet | | 048465 |

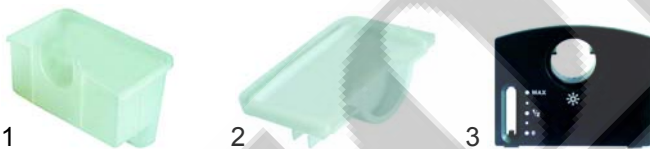

| Fig. | Réf. | Description | Modèle | Réf. C. |
|------|--------|-------------|---------------------|---------|
| 1 | 504707 | réservoir | LS32, LS33, LS61, | 047549 |
| 2 | 504708 | couvercle | LS62, LS63, LS64, | 047551 |
| 3 | 504709 | diaphragme | LS510, LS520, LS521 | 047547 |



| Fig. | Réf. | Description | Modèle | Réf. C. |
|------|--------|-------------|---------------------|---------|
| 1 | 504710 | écrou | | 047550 |
| 2 | 504711 | joint | LS32, LS33, LS61, | 030186 |
| 3 | 504712 | entonnoir | LS62, LS63, LS64, | 047548 |
| 4 | 504713 | tube bac | LS510, LS520, LS521 | 047552 |

Réservoirs d'air

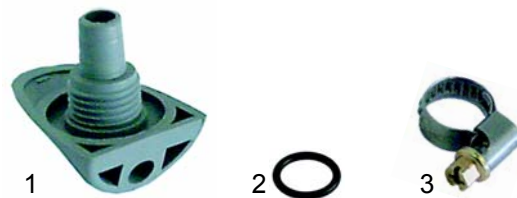

| Fig. | Réf. | Description | Modèle | Réf. C. |
|------|--------|----------------------------------|---|---------|
| 1 | 504617 | réservoir air (pompe de vidange) | LB1, LB2, LS5, LS6, LS7, LS8, LS10, LS12, | 048853 |
| 2 | 504618 | joint | LS14, LS33, LS63, | 068642 |
| 3 | 504619 | collier de serrage | LS64 | 046946 |

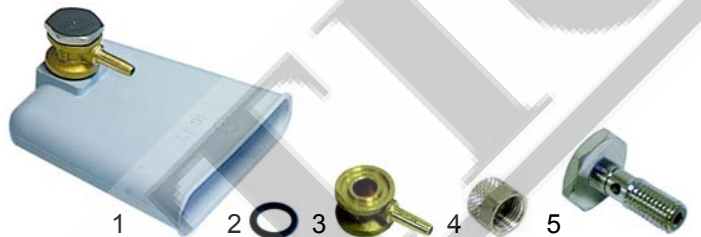

| Fig. | Réf. | Description | Modèle | Réf. C. |
|------|--------|------------------------|---------------|---------|
| 1 | 510103 | réservoir air, complet | | 069515 |
| 2 | 510077 | joint torique | | 069644 |
| 3 | 510105 | connexion pompe | LTB11, LTB12, | 069670 |
| 4 | 510017 | raccord olive | LTB22 | 0A6065 |
| 5 | 510016 | raccord chambre | | 069646 |



| Fig. | Réf. | Description | Modèle | Réf. C. |
|------|--------|---------------|---|---------|
| 1 | 504620 | réservoir air | LS5, LS6, LS7, LS8, | 048308 |
| 2 | 504618 | joint | LS10, LS12, LS14, | 068642 |
| 3 | 504621 | écrou | LS32, LS33, LS61 - LS64 | 049268 |
| 4 | 504622 | réservoir air | LS10 (ancien), LS12 | 046631 |
| 5 | 504623 | joint torique | (ancien), LS360, LS365, LS510, LS520, LS521 | 068573 |
| 6 | 504624 | réservoir air | LS540, LS720, LS860, | 045459 |
| 7 | 504623 | joint SPI | LS1080 | 068573 |

Systèmes de vidange et de filtre



| Fig. | Réf. | Description | Modèle | Réf. C. |
|------|--------|---------------------------------------|----------|---------|
| 1 | 504588 | surverse trop plein | | 049914 |
| 2 | 504589 | surverse trop plein, pompe de vidange | LB1, LB2 | 049915 |
| 3 | 504590 | joint torique | | 049036 |

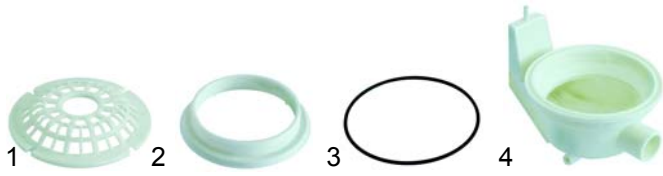

| Fig. | Réf. | Description | Modèle | Réf. C. |
|------|--------|--|----------|---------|
| 1 | 504591 | filtre | LB1, LB2 | 049032 |
| 2 | 504592 | écrou | | 049034 |
| 3 | 504593 | joint torique | | 049033 |
| 4 | 504594 | cuve d'aspiration et de vidange avec réservoir air | | 049035 |

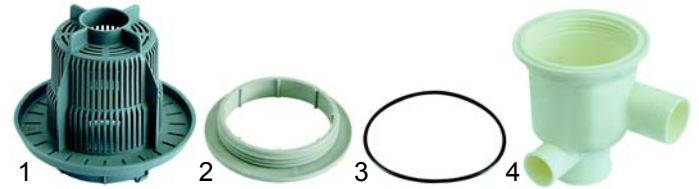

| Fig. | Réf. | Description | Modèle | Réf. C. |
|------|--------|------------------------------|-------------|---------|
| 1 | 504595 | filtre | LS5, LS6, | 048324 |
| 2 | 504596 | écrou | LS7, LS8, | 048326 |
| 3 | 504597 | joint | LS32, LS33, | 048327 |
| 4 | 504598 | corps de bonde et de vidange | LS62, LS63 | 048325 |



| Fig. | Réf. | Description | Modèle | Réf. C. |
|------|--------|--|---------------------|---------|
| 1 | 510038 | surverse trop plein | LTB11, LTB12, LTB22 | 069526 |
| 2 | 518490 | surverse trop plein (pompe de vidange) | | 069527 |
| 3 | 518491 | joint torique | | 069527 |
| 4 | 510045 | Filterpumpe/ complet | | 069574 |



| Fig. | Réf. | Description | Modèle | Réf. C. |
|------|--------|---------------------|------------------|---------|
| 1 | 504599 | surverse trop plein | LS10, LS12, LS14 | 048250 |
| 2 | 504600 | joint | | 048229 |
| 3 | 504601 | corps de bonde | | 049600 |



| Fig. | Réf. | Description | Modèle | Réf. C. |
|------|--------|------------------|---------------------|---------|
| 1 | 510040 | filtre extérieur | LTB11, LTB12, LTB22 | 069528 |
| 2 | 510041 | filtre intérieur | | 069529 |

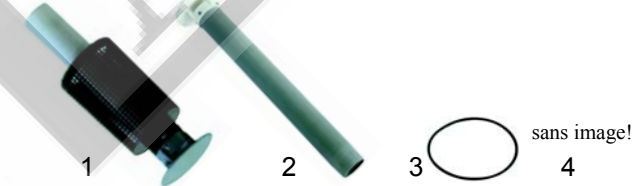

| Fig. | Réf. | Description | Modèle | Réf. C. |
|------|--------|---------------------|--------------|----------------|
| 1 | 510433 | surverse trop plein | LS360 | 068713 |
| 2 | fini | surverse trop plein | LS365 | 046635 |
| 3 | 504578 | joint torique | LS360, LS365 | 045462 |
| 4 | 504604 | corps de bonde | | 046396, 046395 |

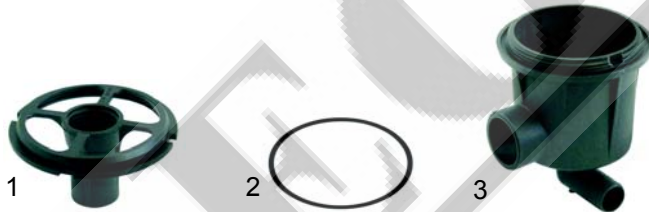

| Fig. | Réf. | Description | Modèle | Réf. C. |
|------|--------|----------------|--------|---------|
| 1 | 518199 | renforcement | LTB11, | 069530 |
| 2 | 510009 | joint torique | LTB12, | 069531 |
| 3 | 518201 | corps de bonde | LTB22 | 069532 |



| Fig. | Réf. | Description | Modèle | Réf. C. |
|------|--------|---------------------|-----------------------------|---------|
| 1 | 510434 | surverse trop plein | LS540, LS720, LS860, LS1080 | 045476 |
| 2 | 504578 | joint torique | | 045462 |
| 3 | 504605 | corps de bonde | LS540, LS720 | 045458 |
| 4 | 504606 | corps de bonde | LS860, LS1080 | 046525 |

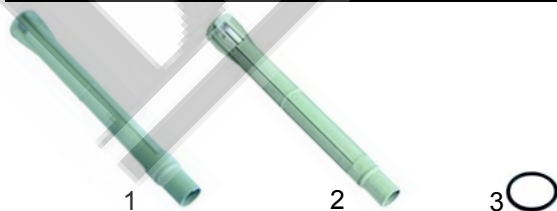

| Fig. | Réf. | Description | Modèle | Réf. C. |
|------|--------|--|-----------------------------|---------|
| 1 | 510770 | surverse trop plein | LS5, LS6, LS7, | 048323 |
| 2 | 510771 | surverse trop plein (pompe de vidange) | LS8, LS32, LS33, LS62, LS63 | 048842 |
| 3 | 510769 | joint | | 046799 |



| Fig. | Réf. | Description | Modèle | Réf. C. |
|------|--------|---------------------|--------------|---------|
| 1 | 510768 | surverse trop plein | LS510, LS520 | 047460 |
| 2 | 504607 | surverse trop plein | LS521 | 047556 |
| 3 | 510769 | joint torique | | 046799 |

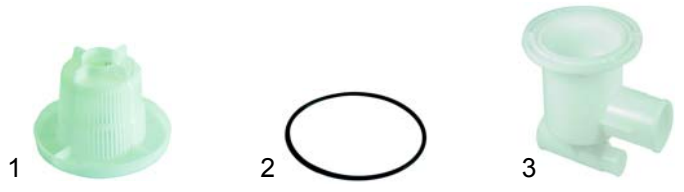

| Fig. | Réf. | Description | Modèle | Réf. C. |
|------|--------|----------------|---------------------|---------|
| 1 | 504608 | filtre | | 047456 |
| 2 | 504609 | joint torique | LS510, LS520, LS521 | 047458 |
| 3 | 504610 | corps de bonde | | 047457 |

Filtre cuve plat



| Fig. | Réf. | Description | Modèle | Réf. C. |
|------|--------|------------------|------------------|---------|
| 1 | 504611 | filtre cuve plat | LB1, LB2 | 049051 |
| 2 | 504612 | filtre cuve plat | LS6 | 049908 |
| 3 | 504613 | filtre cuve plat | LS10, LS12, LS14 | 048252 |



| Fig. | Réf. | Description | Modèle | Réf. C. |
|------|--------|------------------|---------------------------------|---------|
| 1 | 504614 | filtre cuve plat | LS7, LS8, LS32, LS33, LS61 - 64 | 048332 |
| 2 | 504615 | filtre cuve plat | LS510, LS520, LS521 | 047544 |



| Fig. | Réf. | Description | Modèle | Réf. C. |
|------|--------|---------------------|------------------|---------|
| 1 | 504616 | filtre d'aspiration | LS10, LS12, LS14 | 049633 |

Durites d'aspiration et de refoulement



| Fig. | Réf. | Description | Modèle | Réf. C. |
|------|--------|-----------------------|---------------|---------|
| 1 | 504625 | durite d'aspiration | LB1, LB2 | 049041 |
| 2 | 518217 | durite d'aspiration | LTB11, LTB12, | 069537 |
| 3 | 518216 | durite de refoulement | LTB22 | 046878 |



| Fig. | Réf. | Description | Modèle | Réf. C. |
|------|--------|-----------------------|-------------------------|---------|
| 1 | 504626 | durite d'aspiration | LS5, LS6, LS7, LS8, | 045768 |
| 2 | 504627 | durite de refoulement | LS32, LS33, LS61 - LS64 | 046257 |



| Fig. | Réf. | Description | Modèle | Réf. C. |
|------|--------|-----------------------|-----------------------------------|---------|
| 1 | 504628 | durite d'aspiration | LS360, LS365, LS510, LS520, LS521 | 045457 |
| 2 | 504629 | durite de refoulement | LS360, LS365, LS510, | 046398 |
| 3 | 504627 | durite de refoulement | LS520, LS521 | 046257 |



| Fig. | Réf. | Description | Modèle | Réf. C. |
|------|--------|--------------------------------|------------------|---------|
| 1 | 504628 | durite d'aspiration | | 048242 |
| 2 | 504629 | durite de refoulement | | 045456 |
| 3 | 504626 | durite d'aspiration | LS10, LS12, LS14 | 045768 |
| 4 | 504630 | durite de refoulement (ancien) | | 048241 |

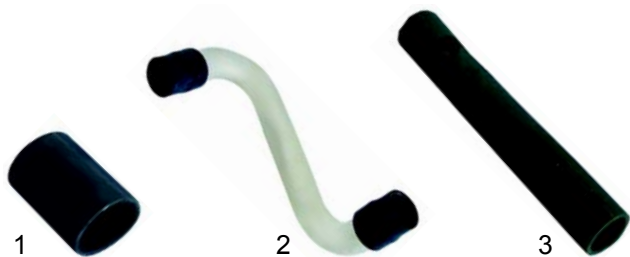

| Fig. | Réf. | Description | Modèle | Réf. C. |
|------|--------|-----------------------|-------------------------------|---------|
| 1 | 504631 | durite d'aspiration | | 045456 |
| 2 | 504632 | durite de refoulement | LS540, LS541, LS720, LS721 | 046372 |
| 3 | 504627 | durite de refoulement | | 046257 |

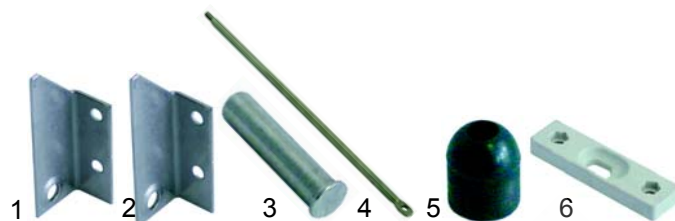

| Fig. | Réf. | Description | Modèle | Réf. C. |
|------|--------|-------------------|--------|---------|
| 1 | 504641 | charnière/ gauche | | 049280 |
| 2 | 504640 | charnière/ droit | | 049279 |
| 3 | 504642 | vis charnière | | 049281 |
| 4 | 504643 | tige | | 049282 |
| 5 | 504644 | support axe | | 049286 |
| 6 | 504645 | embout loqueteau | | 049285 |



| Fig. | Réf. | Description | Modèle | Réf. C. |
|------|--------|-----------------------|-------------------------|---------|
| 1 | 504633 | durite d'aspiration | | 046565 |
| 2 | 504634 | durite de refoulement | LS860, LS861, LS1080 | 046542 |
| 3 | 504635 | durite de refoulement | | 046546 |

Mécanique de porte

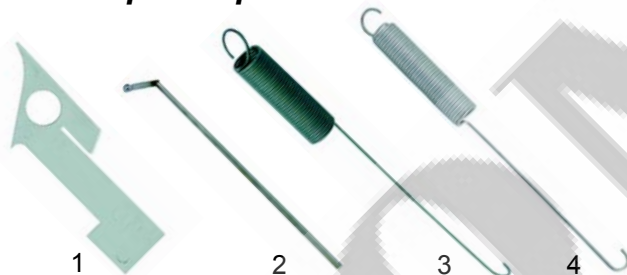

| Fig. | Réf. | Description | Modèle | Réf. C. |
|------|--------|-----------------|----------|---------|
| 1 | 504636 | patte plastique | | 049246 |
| 2 | 504637 | tige ressort | LB1, LB2 | 049030 |
| 3 | 504638 | ressort | LB1 | 049200 |
| 4 | 504639 | ressort | LB2 | 049086 |



| Fig. | Réf. | Description | Modèle | Réf. C. |
|------|--------|-------------------|---------------|---------|
| 1 | 518546 | charnière/ droit | | 069513 |
| 2 | 518547 | charnière/ gauche | LTB11, LTB12, | |
| 3 | 518256 | butée/ droit | LTB22 | 069514 |
| 4 | 518257 | butée/ gauche | | |



| Fig. | Réf. | Description | Modèle | Réf. C. |
|------|--------|-------------------------------|---------------------------|---------|
| 1 | 504646 | levier pour charnière/ droit | | 048813 |
| 2 | 504647 | levier pour charnière/ gauche | | 048814 |
| 3 | 504648 | douille | LS6, LS61, LS62, LS63, | 048812 |
| 4 | 504649 | ressort | LS64 | 048815 |

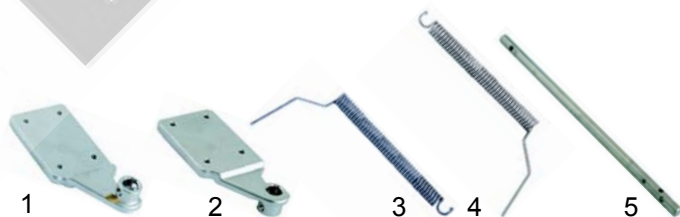

| Fig. | Réf. | Description | Modèle | Réf. C. |
|------|--------|-------------------|--------|---------|
| 1 | 504650 | charnière/ droit | | 048583 |
| 2 | 504651 | charnière/ gauche | | 048582 |
| 3 | 504652 | ressort/ droit | LS7 | 046269 |
| 4 | 504653 | ressort/ gauche | | 046268 |
| 5 | 504654 | arbre cannelé | | 048581 |



| Fig. | Réf. | Description | Modèle | Réf. C. |
|------|--------|-------------------|-------------------------------|----------------|
| 1 | 504655 | charnière/ droit | | 046292 |
| 2 | 504656 | charnière/ gauche | | 046291 |
| 3 | 504652 | ressort/ droit | LS360, LS365, LS540, LS541 | 046269 |
| 4 | 504653 | ressort/ gauche | | 046268 |
| 5 | 504654 | arbre cannelé | | 048581, 046267 |



| Fig. | Réf. | Description | Modèle | Réf. C. |
|------|--------|-------------------------|---------------------|---------|
| 1 | 504657 | charnière | | 048161 |
| 2 | 504658 | vis de charnière | | 047478 |
| 3 | 504659 | boîtier de verrouillage | LS510, LS520, LS521 | 047491 |
| 4 | 504660 | ressort | | 047492 |
| 5 | 504661 | gâche | | 047493 |



| Fig. | Réf. | Description | Modèle | Réf. C. |
|------|--------|-------------|-----------------|---------|
| 1 | 510068 | fermeture | LTB11, LTB12, | 069435 |
| 2 | 510069 | gâche | LTB22 | 069436 |
| 3 | 504662 | fermeture | LS5, LS32, LS33 | 049271 |
| 4 | 504663 | gâche | | 049536 |



| Fig. | Réf. | Description | Modèle | Réf. C. |
|------|--------|----------------|---------------------|---------|
| 1 | 504664 | cadre de porte | LS360, LS365 | 046392 |
| 2 | 504665 | cadre de porte | LS510, LS520, LS521 | 047483 |
| 3 | 504666 | cadre de porte | LS540 | 046270 |

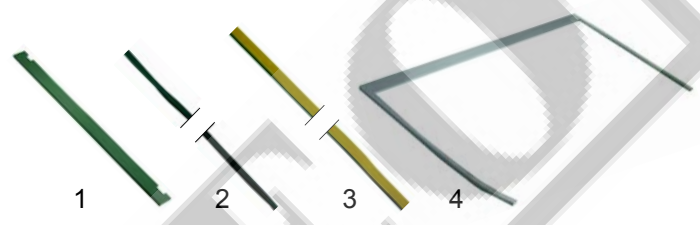

| Fig. | Réf. | Description | Modèle | Réf. C. |
|------|--------|----------------------|-----------------|---------|
| 1 | 504667 | joint porte/ en haut | LB1, LB2 | 049017 |
| 2 | 504668 | joint porte/ en bas | | 049016 |
| 3 | 504669 | joint porte/ en haut | LS5, LS32, LS33 | 046583 |
| 4 | 504670 | joint porte/ en haut | LS6 | 049932 |

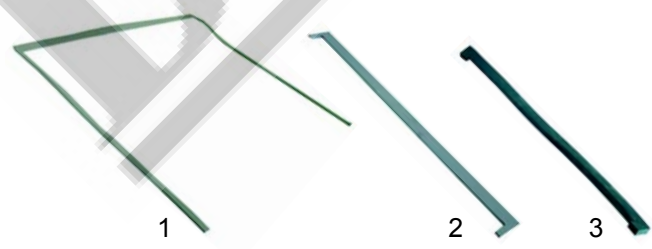

| Fig. | Réf. | Description | Modèle | Réf. C. |
|------|--------|----------------------|--------------|---------|
| 1 | 504671 | joint porte/ en haut | LS7 | 049248 |
| 2 | 504672 | joint porte/ en haut | LS61 - LS64 | 048306 |
| 3 | 504673 | joint porte/ en haut | LS360, LS365 | 046394 |



| Fig. | Réf. | Description | Modèle | Réf. C. |
|------|--------|---------------------|---------------|---------|
| 1 | 504674 | joint porte/ droit | LS510, LS520, | 047454 |
| 2 | 504675 | joint porte/ gauche | LS521 | 047455 |

Mécanique de capot



| Fig. | Réf. | Description | Modèle | Réf. C. |
|------|--------|--------------|----------------------|---------|
| 1 | 504676 | poignée noir | LS720, LS860, LS1080 | 046537 |
| 2 | 504677 | douille | | 046538 |
| 3 | 504678 | poignée noir | LS12 (ancien) | 049430 |
| 4 | 504679 | vis | | 048349 |



| Fig. | Réf. | Description | Modèle | Réf. C. |
|------|--------|--------------|------------|---------|
| 1 | 504680 | poignée noir | LS12, LS14 | 049597 |
| 2 | 504681 | roulette | | 049598 |



| Fig. | Réf. | Description | Modèle | Réf. C. |
|------|--------|-------------|---------------|---------|
| 1 | 504682 | ressort | LS720 | 046615 |
| 2 | 504683 | ressort | LS860, LS1080 | 046540 |
| 3 | 504684 | ressort | LS8 | 048655 |

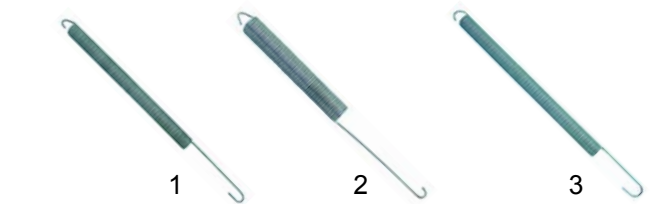

| Fig. | Réf. | Description | Modèle | Réf. C. |
|------|--------|-------------|------------------------------|---------|
| 1 | 504685 | ressort | LS10, LS12, LS14 | 049582 |
| 2 | 504686 | ressort | LS10 (ancien), LS12 (ancien) | 048258 |
| 3 | 504687 | ressort | LS14EA/ AU | 049947 |

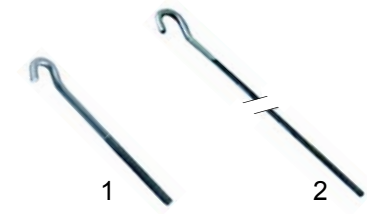

| Fig. | Réf. | Description | Modèle | Réf. C. |
|------|--------|-----------------|--|---------|
| 1 | 504688 | support ressort | LS720, LS860, LS1080, LS8, L10 (ancien), LS12 (ancien) | 075767 |
| 2 | 504689 | support ressort | LS10, LS12, LS14 | 049583 |

Composants électriques

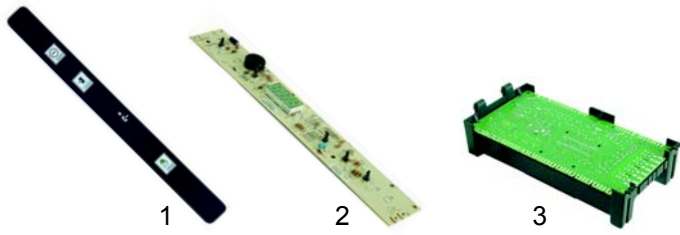

| Fig. | Réf. | Description | Modèle | Réf. C. |
|------|--------|------------------|--------|---------|
| 1 | 400915 | membrane clavier | LS5 | 049956 |
| 2 | 400916 | platine commande | | 0L0047 |
| 3 | 400917 | carte mère | | 0L0046 |

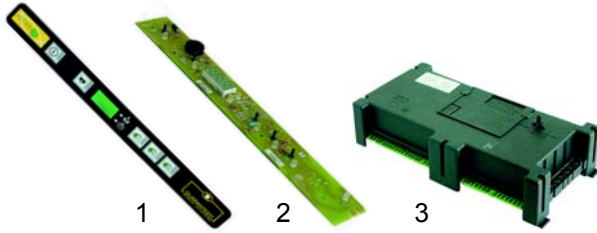

| Fig. | Réf. | Description | Modèle | Réf. C. |
|------|--------|------------------|--------|----------------|
| 1 | 400918 | membrane clavier | LS6 | 049920 |
| 2 | 400919 | platine commande | | 049897 |
| 3 | 400920 | carte mère | | 049910, 0L0045 |

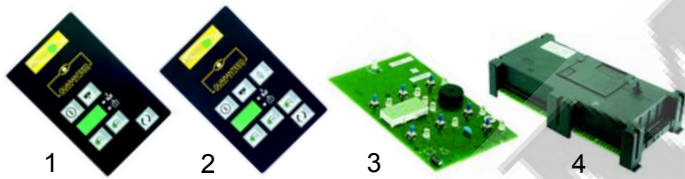

| Fig. | Réf. | Description | Modèle | Réf. C. |
|------|--------|------------------|---------|---------|
| 1 | 400921 | membrane clavier | LS10EA | 0L0008 |
| 2 | 400922 | membrane clavier | LS14EA | 0L0001 |
| 3 | 400923 | platine commande | LS10EA, | 049998 |
| 4 | 400920 | carte mère | LS14EA | 0L0045 |
| 4 | 400961 | carte mère | | 0L0541 |



| Fig. | Réf. | Description | Modèle | Réf. C. |
|------|--------|------------------|--------|---------|
| 1 | 400924 | membrane clavier | LS10 | 049605 |
| 2 | 400925 | membrane clavier | LS12 | 049606 |
| 3 | 400926 | membrane clavier | LS12AU | 049604 |

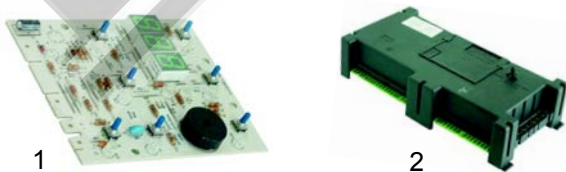

| Fig. | Réf. | Description | Modèle | Réf. C. |
|------|--------|------------------|------------|------------------------|
| 1 | 400927 | platine commande | LS10, LS12 | 049623, 049754 |
| 2 | 400920 | carte mère | | 049622, 049752, 0L0045 |

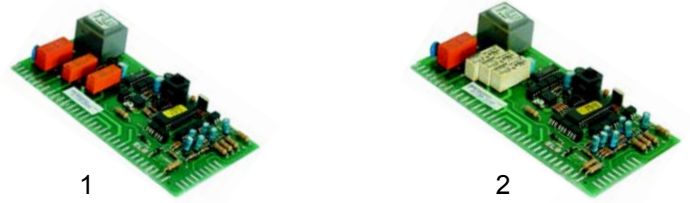

| Fig. | Réf. | Description | Modèle | Réf. C. |
|------|--------|-------------|------------|---------|
| 1 | 400928 | carte mère | LS61, LS62 | 048833 |
| 2 | 400929 | carte mère | LS63, LS64 | 048926 |

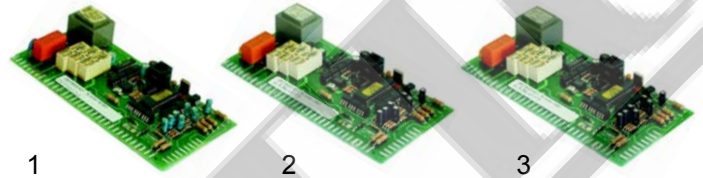

| Fig. | Réf. | Description | Modèle | Réf. C. |
|------|--------|-------------|--------|---------|
| 1 | 400930 | carte mère | LS8DP | 049150 |
| 2 | 400931 | carte mère | LS10DP | 049141 |
| 3 | 400932 | carte mère | LS12DP | 049147 |

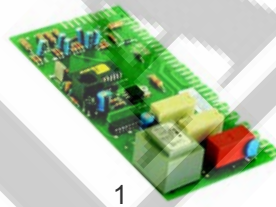

sans image!

| Fig. | Réf. | Description | Modèle | Réf. C. |
|------|--------|--------------------------|--------|---------|
| 1 | 360275 | programmeur électronique | LS32 | 049411 |
| 2 | 360276 | programmeur électronique | LS33 | 049412 |

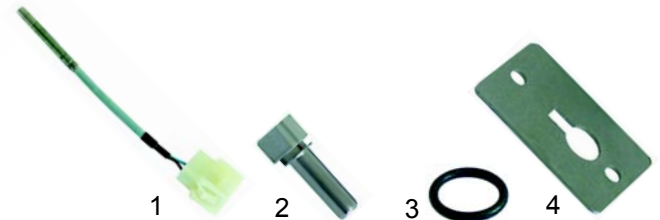

| Fig. | Réf. | Description | Modèle | Réf. C. |
|------|--------|-------------|-------------|---------|
| 1 | 379901 | capteur | LS5, LS6 | 049884 |
| 2 | 379902 | capteur | LS5, LS6, | 049643 |
| 3 | 504574 | joint | LS10, LS12, | 046376 |
| 4 | 504753 | support | LS14 | 049580 |

Panneaux de commande



| Fig. | Réf. | Description | Modèle | Réf. C. |
|------|--------|---------------------|------------|---------|
| 1 | 504714 | panneau de commande | LB1, LB2 | 049061 |
| 2 | 504715 | panneau de commande | LS7 | 048339 |
| 3 | 504716 | panneau de commande | LS32, LS33 | 049313 |

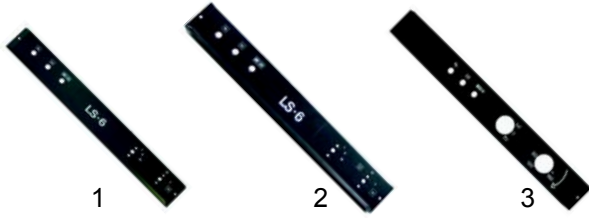

| Fig. | Réf. | Description | Modèle | Réf. C. |
|------|--------|---------------------|------------|------------------|
| 1 | 504717 | panneau de commande | LS61, LS62 | 048827 |
| 2 | 504718 | panneau de commande | LS63 | 048903 |
| 3 | 504719 | panneau de commande | LS520 | 047545 047633 |



| Fig. | Réf. | Description | Modèle | Réf. C. |
|------|--------|---------------------|--------------|------------------|
| 1 | 504720 | panneau de commande | LS521 | 047561 047633 |
| 2 | 504721 | panneau de commande | LS540, LS720 | 046345 |
| 3 | 504722 | panneau de commande | LS860 | 046732 |



| Fig. | Réf. | Description | Modèle | Réf. C. |
|------|--------|---------------------|--------|---------|
| 1 | 504723 | panneau de commande | LS8 | 048648 |
| 2 | 504724 | panneau de commande | LS8DP | 049151 |
| 3 | 504725 | panneau de commande | LS10 | 048470 |

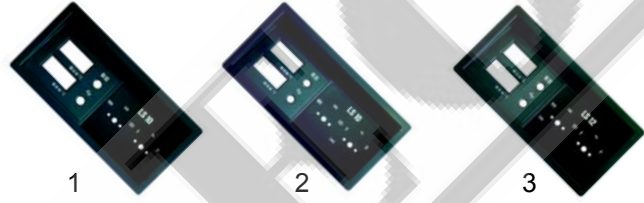

| Fig. | Réf. | Description | Modèle | Réf. C. |
|------|--------|---------------------|--------|---------|
| 1 | 504726 | panneau de commande | LS10 | 048590 |
| 2 | 504727 | panneau de commande | LS10DP | 049143 |
| 3 | 504728 | panneau de commande | LS12 | 048473 |

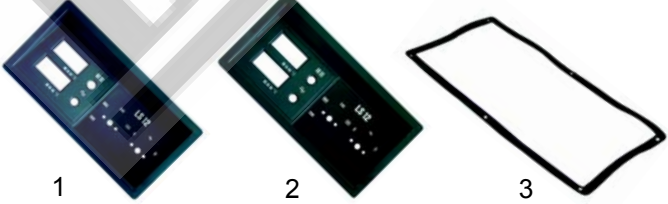

| Fig. | Réf. | Description | Modèle | Réf. C. |
|------|--------|---------------------|-----------|---------|
| 1 | 504729 | panneau de commande | LS12DP | 049148 |
| 2 | 504730 | panneau de commande | LS12HD | 048598 |
| 3 | 504731 | joint | universel | 048274 |

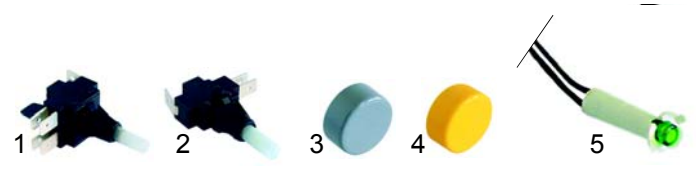

| Fig. | Réf. | Description | Modèle | Réf. C. |
|------|--------|-----------------|----------|---------|
| 1 | 345831 | interrupteur | | 049063 |
| 2 | 345832 | poussoir | LB1, LB2 | 049068 |
| 3 | 345833 | bouton poussoir | | 049062 |
| 4 | 345834 | bouton poussoir | | 049065 |
| 5 | 345836 | voyant | | 049064 |

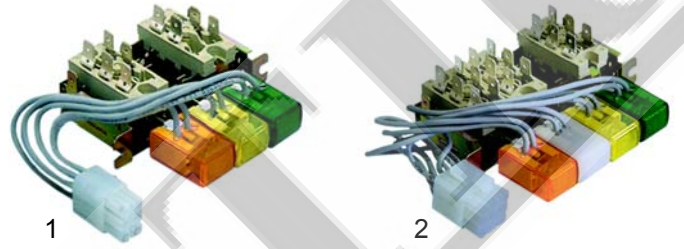

| Fig. | Réf. | Description | Modèle | Réf. C. |
|------|--------|------------------|--------------|---------|
| 1 | 345005 | clavier a touche | LTB11 | 069412 |
| 2 | 345006 | clavier a touche | LTB12, LTB22 | 069413 |

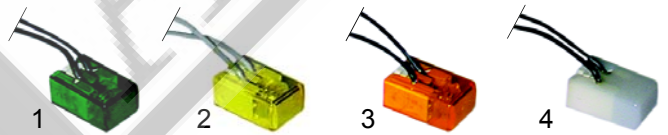

| Fig. | Réf. | Description | Modèle | Réf. C. |
|------|--------|-------------|---------------------|---------|
| 1 | 359001 | voyant | LTB11, LTB12, LTB22 | 069415 |
| 2 | 359002 | voyant | | 069416 |
| 3 | 359003 | voyant | | 069418 |
| 4 | 359006 | voyant | LTB12, LTB22 | 069417 |



| Fig. | Réf. | Description | Modèle | Réf. C. |
|------|--------|--------------|------------|---------|
| 1 | 345824 | interrupteur | LS32, LS33 | 049316 |
| 2 | 345825 | poussoir | | 049315 |
| 3 | 345826 | interrupteur | LS33 | 049326 |



| Fig. | Réf. | Description | Modèle | Réf. C. |
|------|--------|------------------------|------------|---------|
| 1 | 345827 | bouton poussoir/ gris | LS32, LS33 | 049317 |
| 2 | 345828 | bouton poussoir/ jaune | | 049318 |
| 3 | 345829 | bouton poussoir | LS33 | 049325 |
| 4 | 345830 | capot | LS32, LS33 | 049314 |



| Fig. | Réf. | Description | Modèle | Réf. C. |
|------|--------|---------------|--------|---------|
| 1 | 359130 | lampe/ vert | | 048832 |
| 2 | 359126 | douille/ vert | | 075096 |

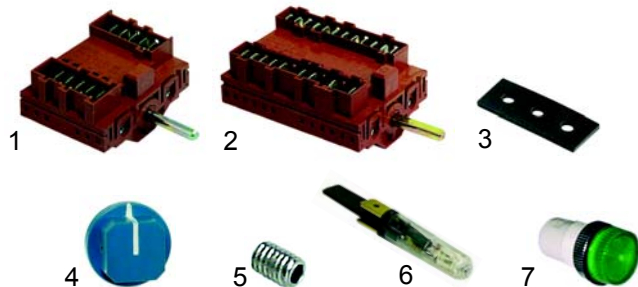

| Fig. | Réf. | Description | Modèle | Réf. C. |
|------|--------|------------------------|-------------|---------|
| 1 | 345169 | interrupteur principal | | 048829 |
| 2 | 345168 | sélecteur programme | | 048828 |
| 3 | 504732 | joint | LS61, LS62, | 046360 |
| 4 | 110907 | manette | LS63, LS64 | 048830 |
| 5 | 504733 | vis pointeau | | 047846 |
| 6 | 359130 | lampe | | 048832 |
| 7 | 359126 | douille/ vert | | 075096 |

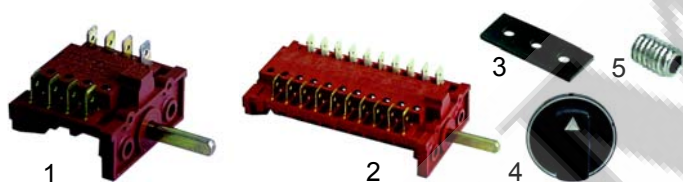

| Fig. | Réf. | Description | Modèle | Réf. C. |
|------|--------|--------------|------------------------|---------|
| 1 | 301087 | arbre a came | | 047498 |
| 2 | 301180 | arbre a came | | 047560 |
| 3 | 504732 | joint | LS510, LS520, LS521 | 046360 |
| 4 | 110910 | manette | | 047842 |
| 5 | 504733 | vis pointeau | | 047846 |



| Fig. | Réf. | Description | Modèle | Réf. C. |
|------|--------|-----------------------------|--------------|----------|
| 1 | 301181 | commutateur sélecteur cycle | LS360 | 047360 |
| 2 | 301182 | commutateur sélecteur cycle | LS365 | 046649 |
| 3 | 504732 | joint | | 046360 |
| 4 | 110911 | manette | LS360, LS365 | 046356 Z |
| 5 | 504734 | vis pointeau | | 046258 |



| Fig. | Réf. | Description | Modèle | Réf. C. |
|------|--------|----------------------|--------------------------------|---------|
| 1 | 359130 | lampe, 230V | | 046241 |
| 1 | 359132 | lampe/ vert, 230V | | 046076 |
| 2 | 359127 | douille/ jaune | LS360, LS365, LS510, LS520, | 075095 |
| 3 | 359126 | douille/ vert | LS521 | 075096 |
| 4 | 359792 | douille/ bleu | | 047750 |
| 5 | 359225 | douille/ transparent | | 046289 |

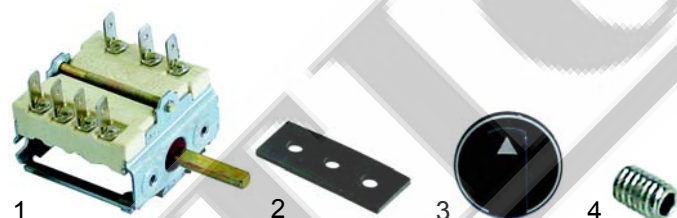

| Fig. | Réf. | Description | Modèle | Réf. C. |
|------|--------|-----------------------------|--------------------------------|---------|
| 1 | 301183 | commutateur sélecteur cycle | | 046350 |
| 2 | 504732 | joint | LS540, LS541, LS720, LS860, | 046360 |
| 3 | 110911 | manette | LS1080 | 046356 |
| 4 | 504733 | vis pointeau | | 047846 |



| Fig. | Réf. | Description | Modèle | Réf. C. |
|------|--------|----------------------|--------------------------------|---------|
| 1 | 359130 | lampe | | 048832 |
| 1 | 359132 | lampe/ vert, 230V | LS540, LS541, LS720, LS860, | 046076 |
| 2 | 359225 | douille/ transparent | LS1080 | 046289 |
| 3 | 359126 | douille/ vert | | 075096 |
| 4 | 359792 | douille/ bleu | | 047750 |

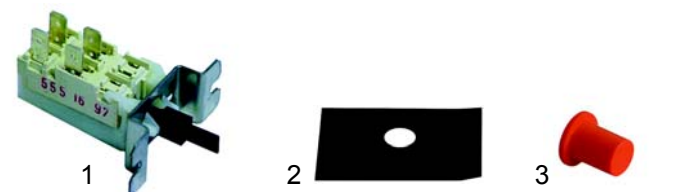

| Fig. | Réf. | Description | Modèle | Réf. C. |
|------|--------|-----------------|--------------------------|----------------|
| 1 | 345021 | interrupteur | LS540, LS541, | 045165, 046348 |
| 2 | 504735 | joint | LS720, LS860, LS1080, | 046298 |
| 3 | 345744 | bouton poussoir | LS360, LS365 | 046293 |

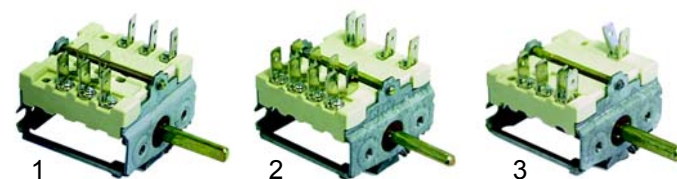

| Fig. | Réf. | Description | Modèle | Réf. C. |
|------|--------|------------------------|--|---------|
| 1 | 345171 | interrupteur principal | LS7, LS10 (à Nr 304_), LS12 (à Nr 304_) | 048271 |
| 2 | 345172 | interrupteur principal | LS8, LS10 (> Nr 305_), LS12 (> Nr 305_) | 048524 |
| 3 | 345170 | sélecteur programme | LS7, LS8, LS10 | 048270 |



| Fig. | Réf. | Description | Modèle | Réf. C. |
|------|--------|------------------------|------------------------------|---------|
| 1 | 301184 | sélecteur programme | LS12 | 048286 |
| 2 | 301185 | interrupteur principal | LS7DP | 048828 |
| 3 | 301186 | interrupteur principal | LS8DP, LS10DP, LS12DP | 049144 |
| 4 | 301187 | sélecteur programme | LS7DP, LS8DP, LS10DP, LS12DP | 049145 |



| Fig. | Réf. | Description | Modèle | Réf. C. |
|------|--------|--------------|-----------------|---------|
| 1 | 504732 | joint | | 046360 |
| 2 | 110912 | manette | LS7 | 048340 |
| 3 | 110913 | manette | LS8, LS10, LS12 | 048402 |
| 4 | 504733 | vis pointeau | | 047846 |



| Fig. | Réf. | Description | Modèle | Réf. C. |
|------|--------|-------------------|------------|---------|
| 1 | 359130 | lampe, 230V | LS7, LS8 | 048488 |
| 1 | 359132 | lampe/ vert, 230V | LS10, LS12 | 048832 |
| 2 | 359126 | douille/ vert | | 075096 |

Programmateurs



| Fig. | Réf. | Description | Modèle | Réf. C. |
|------|--------|---------------------------|--------------------------------|---------|
| 1 | 360279 | 120°/ 300°, 7 cames, 230V | LB1, LB2 (> Nr 716) | 49054 |
| 2 | 360278 | 120°/ 300°, 7 cames, 230V | LB1 (> Nr 717), LB2 (> Nr 717) | 49256 |
| 3 | 360277 | régénération, 230V | LB1, LB2 | 49251 |

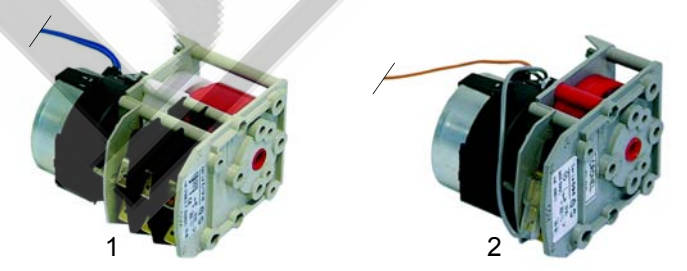

| Fig. | Réf. | Description | Modèle | Réf. C. |
|------|--------|--------------------------|---------------------|----------------|
| 1 | 360024 | 120°, 230V | LTB11, LTB12, LTB22 | 069419, 069669 |
| 2 | 360005 | 20°, 230V (régénération) | | 069420 |

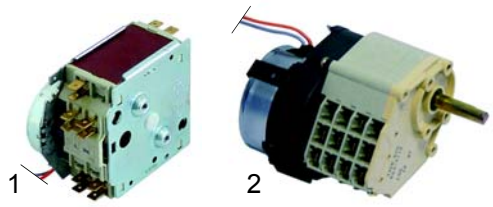

| Fig. | Réf. | Description | Modèle | Réf. C. |
|------|--------|---------------------|---------------------|----------------|
| 1 | 360283 | 230V | LS360, LS365 | 068671 |
| 2 | 360039 | 180°, 4 cames, 230V | LS510, LS520, LS521 | 047497, 048881 |

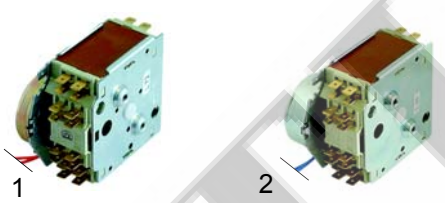

| Fig. | Réf. | Description | Modèle | Réf. C. |
|------|--------|-------------|--------|---------|
| 1 | 360280 | 230V | LS720 | 046621 |
| 2 | 360281 | 230V | LS860 | 046733 |

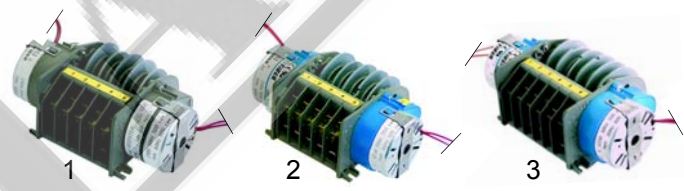

| Fig. | Réf. | Description | Modèle | Réf. C. |
|------|--------|---------------|------------|--------------|
| 1 | 360071 | 5 cames, 230V | LS7 | 48303 |
| 2 | 360073 | 5 cames, 230V | LS8 | 48647 |
| 3 | 360074 | 6 cames, 230V | LS10, LS12 | 48591, 48264 |

Pressostats



| Fig. | Réf. | Description | Modèle | Réf. C. |
|------|--------|--------------------------------------|---------------------|---------|
| 1 | 541177 | 110/ 55, 165/ 135 (pompe de vidange) | LB1, LB2 | 049081 |
| 2 | 541171 | 110/ 55 | | 049058 |
| 3 | 541003 | 55/ 35 | LTB11, LTB12, LTB22 | 069434 |

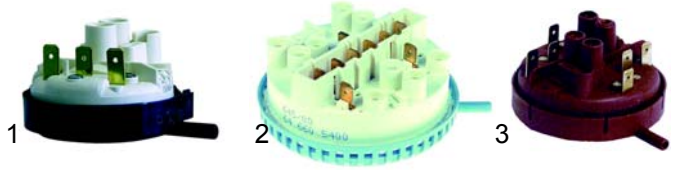

| Fig. | Réf. | Description | Modèle | Réf. C. |
|------|--------|------------------|--------------------------------------|------------------------|
| 1 | 541006 | 60/ 20 | LS360, LS510, LS520, LS540, LS7, LS8 | 049485, 046352, 048723 |
| 2 | 541007 | 68/ 54 | LS365 | 046648 |
| 3 | 541172 | 110/ 85 - 60/ 20 | LS521 | 048752 |



| Fig. | Réf. | Description | Modèle | Réf. C. |
|------|--------|----------------|--|---------|
| 1 | 541008 | 105/ 60 | LS720, LS860, LS1080 | 046601 |
| 2 | 541173 | 2 points | LS7DP, LS8DP, LS61, LS62, LS63, LS64 | 048826 |
| 3 | 541178 | 250/ 130 - 390 | LS10, LS12, LS12DP, LS14 (commande électronique) | 049620 |



| Fig. | Réf. | Description | Modèle | Réf. C. |
|------|--------|-------------|----------------|---------|
| 1 | 541179 | 240/ 130 | LS10, LS12 | 048267 |
| 2 | 541174 | 2 points | LS10DP, LS12DP | 049142 |

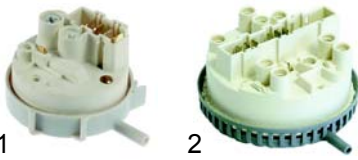

| Fig. | Réf. | Description | Modèle | Réf. C. |
|------|--------|------------------|------------------------------------|----------------|
| 1 | 541175 | 60/ 20 | LS32 | 049305, 049881 |
| 2 | 541176 | 110/ 80 - 60/ 20 | LS32 (> Nr 731_), LS33 (> Nr 731_) | 049361 |

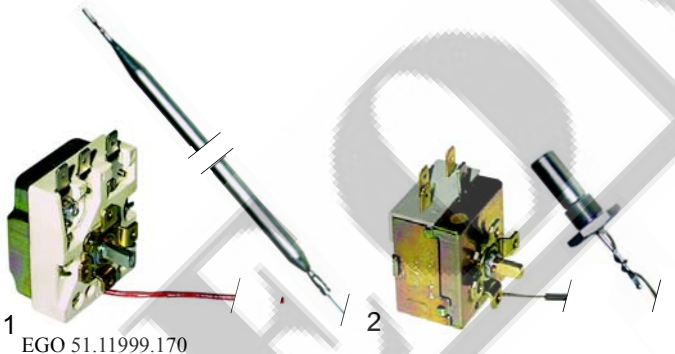

| Fig. | Réf. | Description | Modèle | Réf. C. |
|------|--------|--------------------------|---------------|---------|
| 1 | 390004 | 30 - 90°C (surchauffeur) | LTB11, LTB12, | 069422 |
| 2 | 390005 | 0 - 85°C (cuve) | LTB22 | 069423 |

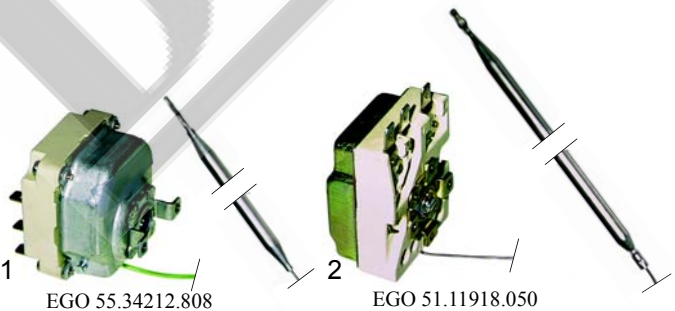

| Fig. | Réf. | Description | Modèle | Réf. C. |
|------|--------|--------------------------|------------|---------|
| 1 | 375210 | 30 - 90°C (surchauffeur) | LB1, LB2 | 049191 |
| 2 | 390467 | 82°C fixe (surchauffeur) | LS32, LS33 | 049255 |

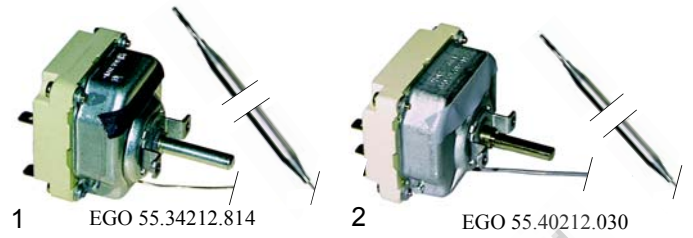

| Fig. | Réf. | Description | Modèle | Réf. C. |
|------|--------|--------------------------|---------------|---------|
| 1 | 390038 | 30 - 90°C (surchauffeur) | LS360, LS365 | 045169 |
| 2 | 375061 | 30 - 90°C (surchauffeur) | LS360, LS365D | 46413 |

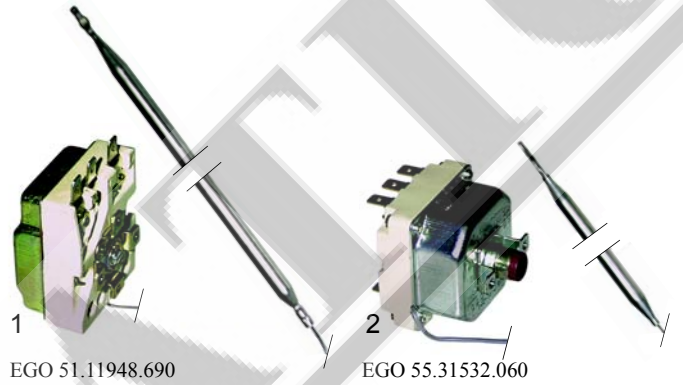

| Fig. | Réf. | Description | Modèle | Réf. C. |
|------|--------|--|--|------------------------|
| 1 | 390030 | 30 - 90°C (surchauffeur) | LS7, LS8, LS10, LS12, LS540, LS720, LS860, LS1080, LS61 - LS64 | 048266, 068012, 049243 |
| 2 | 390165 | thermostat de sécurité, 140°C (surchauffeur) | LS520D, LS521D, LS540, LS720, LS860, LS1080 | 051644 |



| Fig. | Réf. | Description | Modèle | Réf. C. |
|------|--------|--------------------|--|------------------------|
| 1 | 390101 | thermostat contact | LS360, LS365, LS510, LS520, LS521, LS540, LS720, LS860, LS1080, LS7, LS8, LS10, LS12 | 045495, 048487, 047508 |
| 2 | 390466 | thermostat contact | LS510, LS520, LS521 | 048166, 048631 |



| Fig. | Réf. | Description | Modèle | Réf. C. |
|------|--------|--|--|----------------|
| 1 | 390468 | thermostat contact (cuve) | LS - DP, LB1, LB2, LS32, LS33, LS61 - LS64 | 48804 |
| 2 | 390138 | thermostat de sécurité, 112°C (surchauffeur) | LB1, LB2, LS32, LS33, LS61 - LS64, | 048887, 048287 |
| 3 | 504736 | support thermostat | LS7, LS8, LS10, LS12 | 048987 |

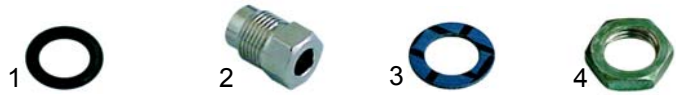

| Fig. | Réf. | Description | Modèle | Réf. C. |
|------|--------|----------------|---------------------|---------|
| 1 | 504544 | joint torique | universel | 067898 |
| 2 | 504738 | vis | | 067899 |
| 3 | 510417 | joint | LTB11, LTB12, LTB22 | |
| 4 | 521134 | écrou, M14 x 1 | | |

Micro-rupteurs

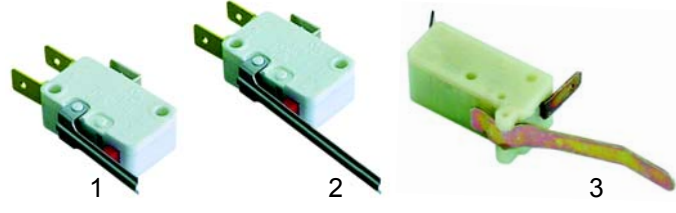

| Fig. | Réf. | Description | Modèle | Réf. C. |
|------|--------|---------------|--|------------------------|
| 1 | 345257 | micro-rupteur | LTB11, LTB12, LTB22 | 069484 |
| 2 | 345254 | micro-rupteur | LS360, LS365, LS510, LS520, LS521, LS540 | 047485, 046286, 046379 |
| 3 | 345815 | micro-rupteur | LS720, LS860, LS1080 | 060722 |

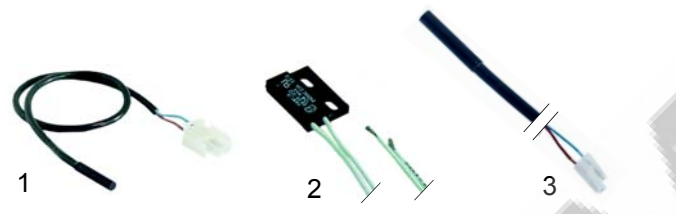

| Fig. | Réf. | Description | Modèle | Réf. C. |
|------|--------|--------------------------|---------------------------|---------|
| 1 | 345816 | micro-rupteur magnétique | LB1, LB2, LS8, LS10, LS12 | 048486 |
| 2 | 345117 | micro-rupteur magnétique | LS7 (bis1994) | 048392 |
| 3 | 345818 | micro-rupteur magnétique | LS7 (> 1994) | 048893 |



| Fig. | Réf. | Description | Modèle | Réf. C. |
|------|--------|--------------------------|--|---------|
| 1 | 345819 | micro-rupteur magnétique | LS7DP, LS8DP, LS10DP, LS12DP, LS61, LS62, LS63, LS64 | 048831 |
| 2 | 345820 | micro-rupteur magnétique | LS32, LS33 | 049226 |
| 3 | 345821 | commande électronique | LS5, LS6, LS10, LS12, LS14, LS10DP | 049621 |



| Fig. | Réf. | Description | Modèle | Réf. C. |
|------|--------|---|----------------------|---------|
| 1 | 345822 | micro-rupteur magnétique/régulateur de niveau | LS8, LS10, LS12 | 049478 |
| 2 | 345823 | micro-rupteur fin de course | LS720, LS860, LS1080 | 048159 |

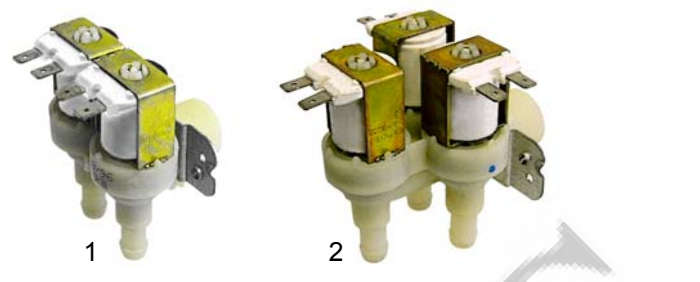

| Fig. | Réf. | Description | Modèle | Réf. C. |
|------|--------|---------------|----------|---------|
| 1 | 370019 | 2 voies, 230V | | 049056 |
| 2 | 370023 | 3 voies, 230V | LB1, LB2 | 049077 |

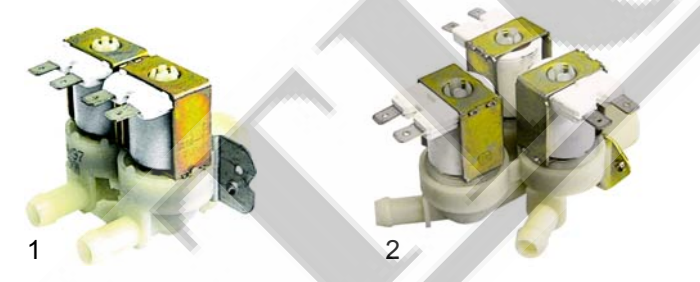

| Fig. | Réf. | Description | Modèle | Réf. C. |
|------|--------|---------------|--------------|---------|
| 1 | 370021 | 2 voies, 230V | LTB11 | 069463 |
| 2 | 370025 | 3 voies, 230V | LTB12, LTB22 | 069464 |

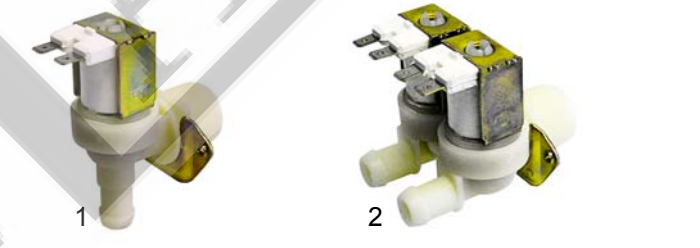

| Fig. | Réf. | Description | Modèle | Réf. C. |
|------|--------|---------------|--|--|
| 1 | 370016 | 1 voie, 230V | LS7, LS8, LS10, LS12, LS510, LS520, LS521, LS540, LS720, LS860, LS1080, LS5, LS61 - LS64 | 047529, 048178, 047843, 046320, 048898, 048817, 048894 |
| 2 | 370022 | 2 voies, 230V | LS_HD | 049230 |

Relais

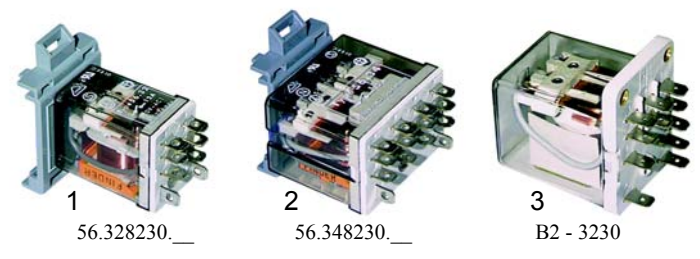

| Fig. | Réf. | Description | Modèle | Réf. C. |
|------|--------|--------------------------------|---|---------|
| 1 | 380183 | 2 contact inverseur, 12A (AC1) | LB1, LB2, LS7, LS10 (à Nr 304 _), LS12 (à Nr 304 _) | 48438 |
| 2 | 380196 | 4 contact inverseur, 12A (AC1) | LB1, LB2, LS10 (> Nr 305 _), LS12 (> Nr 305) | 48611 |
| 3 | 380131 | 3 contact inverseur, 16A (AC1) | LS360, LS365, LS540, LS720, LS860, LS1080 | 046380 |



| Fig. | Réf. | Description | Modèle | Réf. C. |
|------|--------|--|---|---------|
| 1 | 380318 | 2 gonds contact, 16A (AC1) | LS7DP, LS8DP, LS10DP, LS12DP, LS32, LS33, LS61 - LS64 | 048888 |
| 2 | 380622 | Relais temporisé, 0,05sec. - 60h (multifonction) | LS_HD | 049235 |
| 3 | 380136 | soche | | 049236 |

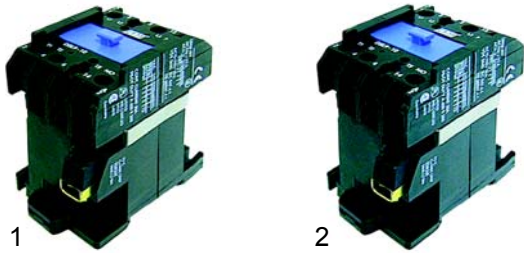

| Fig. | Réf. | Description | Modèle | Réf. C. |
|------|--------|---|---|----------------|
| 1 | 380203 | 3 gonds contact/ 1 contact ouvert, 230V | LS7, LS8, LS10, LS12, LS14, LS32/4,5, LS33/4,5, LS61 - LS64 | 048403, 048825 |
| 2 | 380204 | 230V | LS540, LS720, LS860, LS1080 | 075796, 082986 |

Technique de dosage

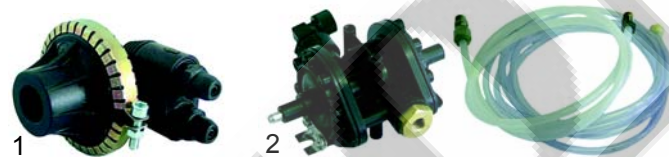

| Fig. | Réf. | Description | Modèle | Réf. C. |
|------|--------|------------------------|---|----------------|
| 1 | 361370 | Glados (auto-aspirant) | LB1, LB2, LS5, LS32, LS33, LS7 (> Nr 545_), LS8 (> Nr 545_), LS10 (> Nr 242_), LS12 (> Nr 242_) | 048715, 049484 |
| 2 | 361008 | Lang (auto-aspirant) | LS10 (à Nr 241_), LS12 (à Nr 241_9), LS360, LS365, LS510, LS520, LS521, LS540, LS720, LS860, LS1080 | 048498, 045478 |



| Fig. | Réf. | Description | Modèle | Réf. C. |
|------|--------|-------------------------|---------------------|----------------|
| 1 | 361004 | DB2, 230V (électrique) | LTB11, LTB12, LTB22 | 069478, 069921 |
| 2 | 361113 | bouchon magnétique, DB2 | | 049625 |
| 3 | 361013 | Lang, 230V (électrique) | | 048580 |



| Fig. | Réf. | Description | Modèle | Réf. C. |
|------|--------|--|------------------------------------|---------|
| 1 | 361152 | produit de lavage (pompe péristaltique) | LS6, LS10, LS12, LS14 | 049624 |
| 2 | 361150 | produit de rinçage (pompe péristaltique) 0,4 l | (électronique-platine de commande) | |
| 2 | 361151 | produit de rinçage (pompe péristaltique) 1,5 l | | 049625 |



| Fig. | Réf. | Description | Modèle | Réf. C. |
|------|--------|-----------------------|--------|---------|
| 1 | 361141 | filtre réservoir | | 049356 |
| 2 | 361270 | raccord tétine doseur | | 049557 |
| 3 | 361147 | clapet anti-retour | | |



| Fig. | Réf. | Description | Modèle | Réf. C. |
|------|--------|-----------------|--------|---------|
| 1 | 361134 | tuyau (produit) | | 049149 |
| 2 | 361135 | tuyau (rinçage) | | 049148 |

Résistance

Cuve-résistance

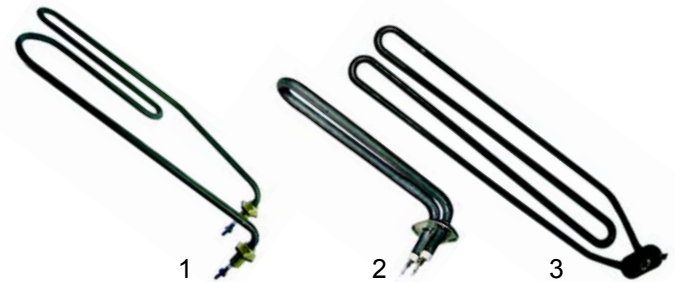

| Fig. | Réf. | Description | Modèle | Réf. C. |
|------|--------|-------------|--|----------------|
| 1 | 415010 | 2000W, 230V | LTB11, LTB12, LTB22 | 069437, 069671 |
| 2 | 415272 | 800W, 230V | LB1, LB2 | 049059 |
| 3 | 415070 | 2200W, 230V | LS6, LS7, LS8, LS10, LS12, LS32, LS33, LS61 - LS64 | 048228, 048924 |
| 3 | 416133 | 2000W, 230V | LS5 | 049954 |

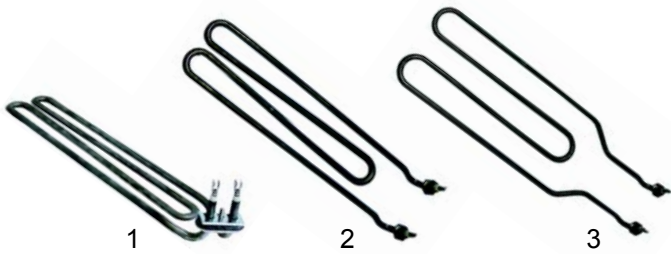

| Fig. | Réf. | Description | Modèle | Réf. C. |
|------|--------|-------------|--|--------------------------------|
| 1 | 416132 | 3000W, 230V | LS10EA, LS14 | 048491 |
| 2 | 415072 | 2200W, 230V | LS360, LS365, LS520D, LS521D, LS720, LS860, LS1080 | 046404, 046418, 048000, 048086 |
| 3 | 415073 | 2200W, 230V | LS510, LS520, LS521, LS540 | 046284, 047507, 047848, 047506 |

Cuve-résistance/ accessoire



| Fig. | Réf. | Description | Modèle | Réf. C. |
|------|--------|----------------|-----------|---------|
| 1 | 510416 | joint | | 069438 |
| 2 | 520231 | écrou, M10 x 1 | | |
| 3 | 521132 | joint torique | universel | 046223 |
| 4 | 521133 | écrou, M14 x 1 | | 046223 |
| 5 | 510387 | joint | | |
| 6 | 510388 | flasque | | 048483 |

Surchauffeurs-résistance

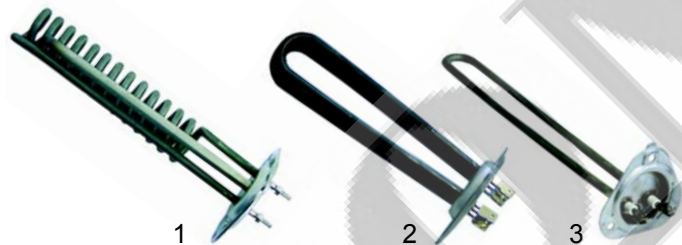

| Fig. | Réf. | Description | Modèle | Réf. C. |
|------|--------|-----------------|-----------------------|----------------|
| 1 | 415002 | 3000W, 230V | LTB11, LTB12, LTB22 | 069455, 069672 |
| 2 | 415174 | 3000W, 3 x 230V | LB1, LB2, LS62 - LS64 | 048927 |
| 3 | 416130 | 2800W, 230V | LS32, LS33 | 049371 |



| Fig. | Réf. | Description | Modèle | Réf. C. |
|------|--------|-----------------|----------------------|----------------|
| 1 | 416135 | 2800W, 230V | LS5 | 049980 |
| 2 | 416128 | 4500W, 3 x 230V | LS5 | 049955 |
| 3 | 415067 | 4500W, 3 x 230V | LS7/ 9, LS8/ 9, LS12 | 048928, 048284 |



| Fig. | Réf. | Description | Modèle | Réf. C. |
|------|--------|-----------------|------------------------------------|------------------------|
| 1 | 415068 | 6000W, 3 x 230V | LS7, LS8, LS10 | 048513, 048221 |
| 2 | 416129 | 6000W, 3 x 230V | LS6 | 048898 |
| 3 | 416131 | 4500W, 3 x 230V | LS32, LS33, LS540D, LS720D, LS860D | 049307, 052905, 026453 |



| Fig. | Réf. | Description | Modèle | Réf. C. |
|------|--------|--------------|----------------|---------|
| 1 | 415066 | 4500W, 230V | LS520D, LS521D | 047847 |
| 2 | 415080 | 6000W, 230V | | |
| 3 | 416134 | 10500W, 230V | LS10EA, LS14 | 049997 |



| Fig. | Réf. | Description | Modèle | Réf. C. |
|------|--------|-----------------|---------------------|--------------------------------|
| 1 | 415597 | 3000W, 3 x 230V | LS510, LS520, LS521 | 066109, 047505 |
| 2 | 415069 | 4500W, 3 x 230V | LS360, LS720, LS860 | 065557, 045518, 046623, 046627 |
| 3 | 415379 | 6000W, 3 x 230V | LS1080 | 051632, 066110 |



| Fig. | Réf. | Description | Modèle | Réf. C. |
|------|--------|---------------|--------|---------|
| 1 | 510408 | joint torique | | 003362 |
| 2 | 520236 | flasque | | 065558 |

Surchauffeurs



| Fig. | Réf. | Description | Modèle | Réf. C. |
|------|--------|--------------|---------------------|---------|
| 1 | 504739 | surchauffeur | LB1, LN2 | 049053 |
| 2 | 504740 | surchauffeur | LTB11, LTB12, LTB22 | 069453 |
| 3 | 504741 | surchauffeur | LS360, LS365 | 046294 |



| Fig. | Réf. | Description | Modèle | Réf. C. |
|------|--------|--------------|--|---------|
| 1 | 504750 | surchauffeur | LS10EH, LS14 | 049987 |
| 2 | 504751 | surchauffeur | LS10, LS12 (électronique-platine de commande) | 049632 |

Pompes

Pompes de vidange



| Fig. | Réf. | Description | Modèle | Réf. C. |
|------|--------|-------------|--|---------|
| 1 | 500392 | 34W, 230V | LB1, LB2, LS33, LS63, LS64, LS6_DP, LS7DP, LS8DP, LS10DP, LS12DP | 048844 |
| 2 | 500207 | 90W, 230V | LS365 | 046647 |
| 3 | 500206 | 90W, 230V | LS521 | 047562 |

Electropompes rinçage



| Fig. | Réf. | Description | Modèle | Réf. C. |
|------|--------|-------------|--|---------|
| 1 | 500393 | 350W, 230V | LB1, LB2, LS32, LS33, LS62HD | 048910 |
| 2 | 500394 | 280W, 230V | LS6EA, LS10/LS12/LS14 - (électronique-platine de commande) | 049310 |
| 3 | 500395 | 350W, 230V | LS8HD, LS10HD, LS12HD | 049229 |

Pompes de lavage



| Fig. | Réf. | Description | Modèle | Vergleichs-Nr. |
|------|--------|-------------|---------------------------------------|--------------------------------|
| 1 | 500129 | 280W, 230V | LB1, LB2 | 049057 |
| 2 | 500003 | 290W, 230V | LTB11, LTB12, LTB22 | 069450, 069804, 069675, 069805 |
| 3 | 500114 | 740W, 230V | LS32, LS33, LS61 - LS64, LS7DP, LS8DP | 048885 |

sans image!

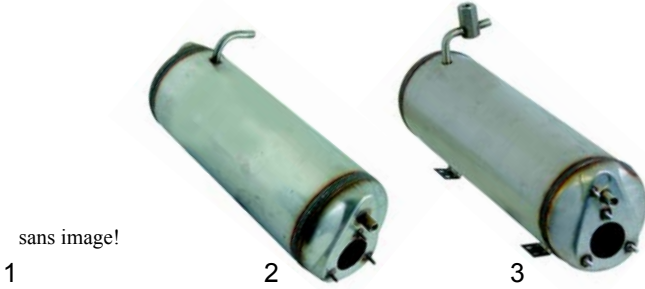

| Fig. | Réf. | Description | Modèle | Réf. C. |
|------|--------|--------------|----------------------|---------|
| 1 | 504742 | surchauffeur | LS510, LS520, LS521 | 048194 |
| 2 | 504743 | surchauffeur | LS540 | 048197 |
| 3 | 504744 | surchauffeur | LS720, LS860, LS1080 | 047950 |



| Fig. | Réf. | Description | Modèle | Réf. C. |
|------|--------|--------------|--------------------------------------|----------------|
| 1 | 504745 | surchauffeur | LS32, LS33 | 049336 |
| 2 | 504746 | surchauffeur | LS61, LS6EP, LS7, LS8, LS10 | 048548, 048341 |
| 3 | 504747 | surchauffeur | LS62, LS63, LS64, LS7/9, LS8/9, LS12 | 048484, 048727 |

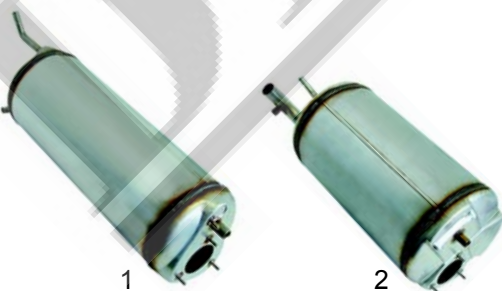

| Fig. | Réf. | Description | Modèle | Réf. C. |
|------|--------|--------------|--------|---------|
| 1 | 504748 | surchauffeur | LS5 | 049958 |
| 2 | 504749 | surchauffeur | LS6 | 049902 |



| Fig. | Réf. | Description | Modèle | Réf. C. |
|------|--------|-----------------|-----------------------------------|---------|
| 1 | 500090 | 550W, 230V | LS360, LS365, LS510, LS520, LS521 | 046370 |
| 2 | 500396 | 750W, 230V | LS5, LS6 | 049876 |
| 3 | 500113 | 740W, 230V (3~) | LS7, LS8 | 048304 |



| Fig. | Réf. | Description | Modèle | Réf. C. |
|------|--------|-------------------|------------------|---------|
| 1 | 500397 | 1kW, 400V, (3~) | LS860, LS1080 | 047708 |
| 2 | 500115 | 1,5kW, 400V, (3~) | LS10, LS12, LS14 | 048216 |



| Fig. | Réf. | Description | Modèle | Réf. C. |
|------|--------|-----------------|---------------|---------|
| 1 | 500112 | 550W, 230V | LS540D | 046574 |
| 2 | 500056 | 550W, 400V (3~) | LS540D, LS720 | 046346 |

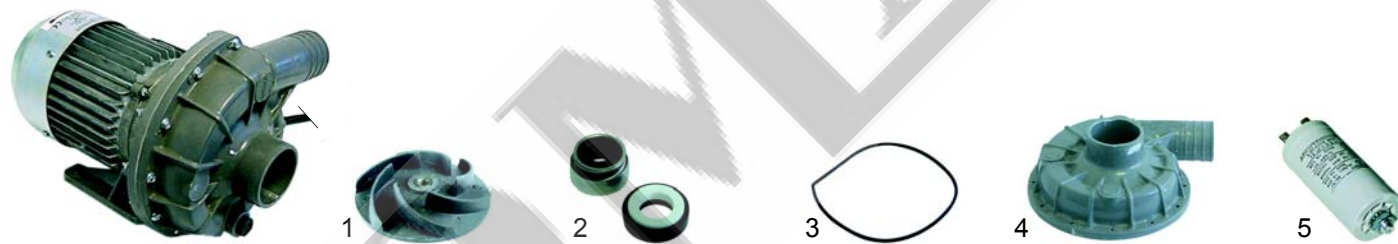

| Pompe | | 1 Turbine | | 2 Joint d'étanchéité | | 3 Joint de boîtier | | 4 Flasque de pompe | | 5 Condensateur | |
|--------|---------|-----------|---------|----------------------|---------|--------------------|---------|--------------------|---------|----------------|---------|
| Réf. | Réf. C. | Réf. | Réf. C. | Réf. | Réf. C. | Réf. | Réf. C. | Réf. | Réf. C. | Réf. | Réf. C. |
| 500003 | 069804 | 510615 | 69545 | 510693 | 69543 | 510554 | 69544 | 510512 | - | 365013 | 69541 |
| 500056 | 046346 | 510601 | | 510693 | | 510551 | | 510502 | | -- | |
| 500090 | 046370 | 521237 | | 510692 | | 521709 | | 521531 | | 365014 | |
| 500112 | 046574 | 510601 | | 510693 | | 510551 | | 510502 | | -- | |
| 500113 | 048304 | 521271 | | 510692 | | 521709 | | 521531 | | | |
| 500114 | 048885 | 509021 | | 510692 | | 521709 | | 521531 | | 365021 | |
| 500115 | 048216 | 510602 | | 510693 | | 510551 | | 521515 | | -- | |
| 500129 | 049057 | 521227 | | 510692 | | 521705 | | 521522 | | 365012 | |
| 500394 | 049310 | 521206 | | 510695 | | 509002 | | 510384 | | 365012 | |
| 500396 | 049876 | 521208 | | 510692 | | 521702 | | 521506 | | 365021 | |
| 500397 | 047708 | 521216 | | 510693 | | 510551 | | 521514 | 48059 | -- | |

Notes

DEOMATIC

DeoMatic Horeca-Industrie s.p.r.l.

Pièces détachées pour Cuisines Industrielles

34 rue des alliés

Bongenotenstraat 34

1190 Bruxelles

1190 Brussel

Tel. : 02 343 97 64

Fax : 02 343 90 31

deomatic@skynet.be

www.deomatic.be

Partner of  **GEV GROUP**

Réf.: P090302801

